



*Changes for the Better*

PASSENGER ELEVATORS  
(HIGH-SPEED CUSTOM-TYPE)

for a greener tomorrow



Quality  
inMotion 

A low-angle, upward-looking photograph of several modern skyscrapers with glass facades. The sun is shining brightly from a gap in the clouds at the top center, creating a lens flare and illuminating the scene. The perspective makes the buildings appear to converge towards the top of the frame.

NexWay



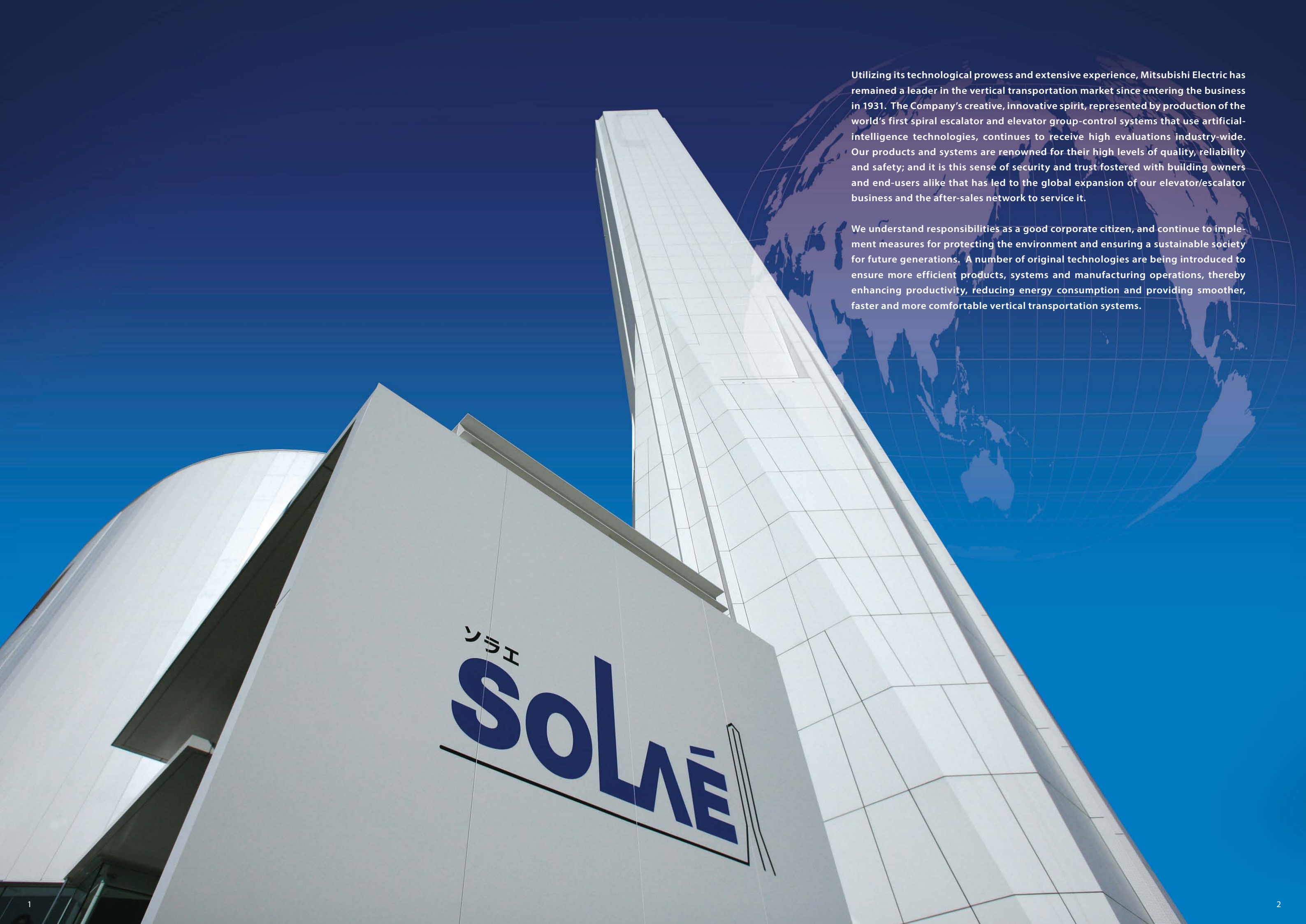

Utilizing its technological prowess and extensive experience, Mitsubishi Electric has remained a leader in the vertical transportation market since entering the business in 1931. The Company's creative, innovative spirit, represented by production of the world's first spiral escalator and elevator group-control systems that use artificial-intelligence technologies, continues to receive high evaluations industry-wide. Our products and systems are renowned for their high levels of quality, reliability and safety; and it is this sense of security and trust fostered with building owners and end-users alike that has led to the global expansion of our elevator/escalator business and the after-sales network to service it.

We understand responsibilities as a good corporate citizen, and continue to implement measures for protecting the environment and ensuring a sustainable society for future generations. A number of original technologies are being introduced to ensure more efficient products, systems and manufacturing operations, thereby enhancing productivity, reducing energy consumption and providing smoother, faster and more comfortable vertical transportation systems.

三菱電機  
**SOLWE**



# Premium Elevators Custom-designed to Match Your Needs



Mitsubishi Electric high-speed elevators are designed to keep pace with the vertical growth of cities as buildings soar to ever greater heights. Our premium elevators guarantee high levels of passenger safety and comfort, and can be customized for diverse applications including office buildings, hotels and shopping centers. We can tailor specifications to meet your exact needs and add a distinctive touch that sets your building apart from the rest.



# Principle

Based on our policy, "Quality in Motion", we provide elevators and escalators that will satisfy our customers with high levels of comfort, efficiency, ecology and safety.



**Safety**

**Ecology**

**Comfort**

**Efficiency**

Mitsubishi Electric elevators, escalators and building management systems are always evolving, helping achieve our goal of being the No.1 brand in quality. In order to satisfy customers in all aspects of comfort, efficiency and safety while realizing a sustainable society, quality must be of the highest level in all products and business activities, while priority is placed on consideration for the environment. As the times change, Mitsubishi Electric promises to utilize the collective strengths of its advanced and environmental technologies to offer its customers safe and reliable products while contributing to society.

## We strive to be green in all of our business activities.

We take every action to reduce environmental burden during each process of our elevators' and escalators' lifecycle.



# Contents

Speed/Comfort	7 - 8
Ecology/Safety	9 - 10
Efficiency	11 - 12
Displays	13
IT Solutions	14
Ceiling Designs/Car Operating Panels Hall Signal Fixtures/Button Line-up/Interior/Hall Designs	15 - 30
Materials and Colors	31 - 32
Features	33 - 36
Specifications	37
Important Information on Elevator Planning	38

## Application

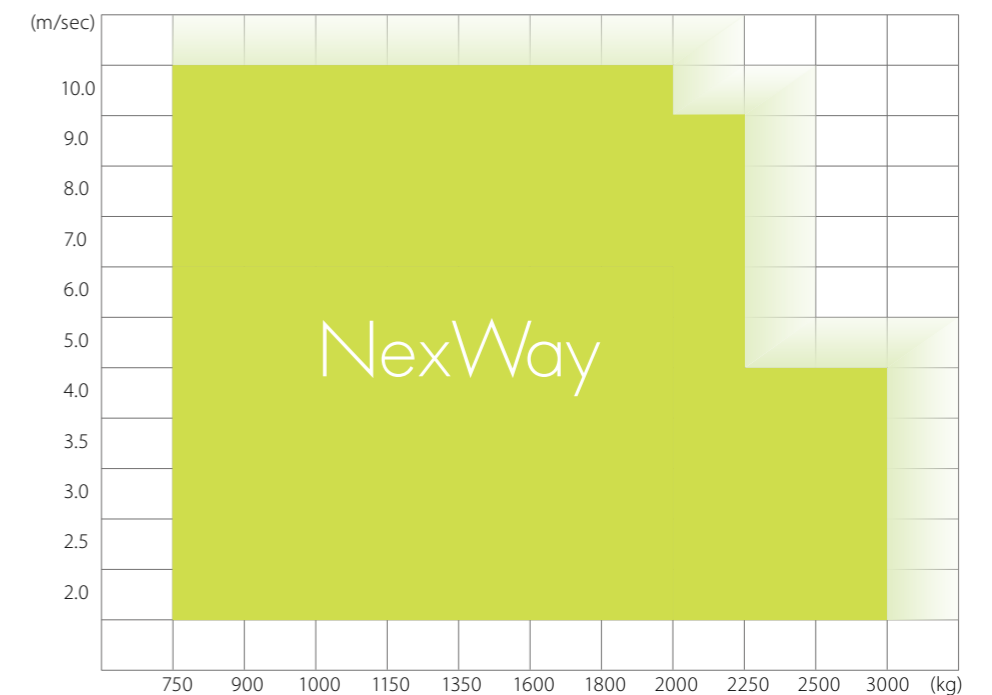



# Speed

## Traction Machine with PM Motor

(PM motor: Permanent magnet motor)

The joint-lapped core built into the PM motor of the traction machine features flexible joints. The iron core acts like a hinge, which allows coils to be wound around the core more densely, resulting in improved motor efficiency and compactness. A high-density magnetic field is produced, enabling lower use of energy and resources and reduced CO<sub>2</sub> emissions.

## Super High-rise Rope Mechanics

Mitsubishi Electric's new sflEX-rope™ comprising bundles of high-intensity steel wire strands, each covered with plastic, offers higher intensity than conventional rope for safe operation despite the greater weight of longer ropes. Each wire has a higher density and wider cross-sectional area than conventional rope, which helps to reduce rope stretching caused when passengers step into the elevator.

The sflEX-rope™ is a trademark of Mitsubishi Electric Corporation.

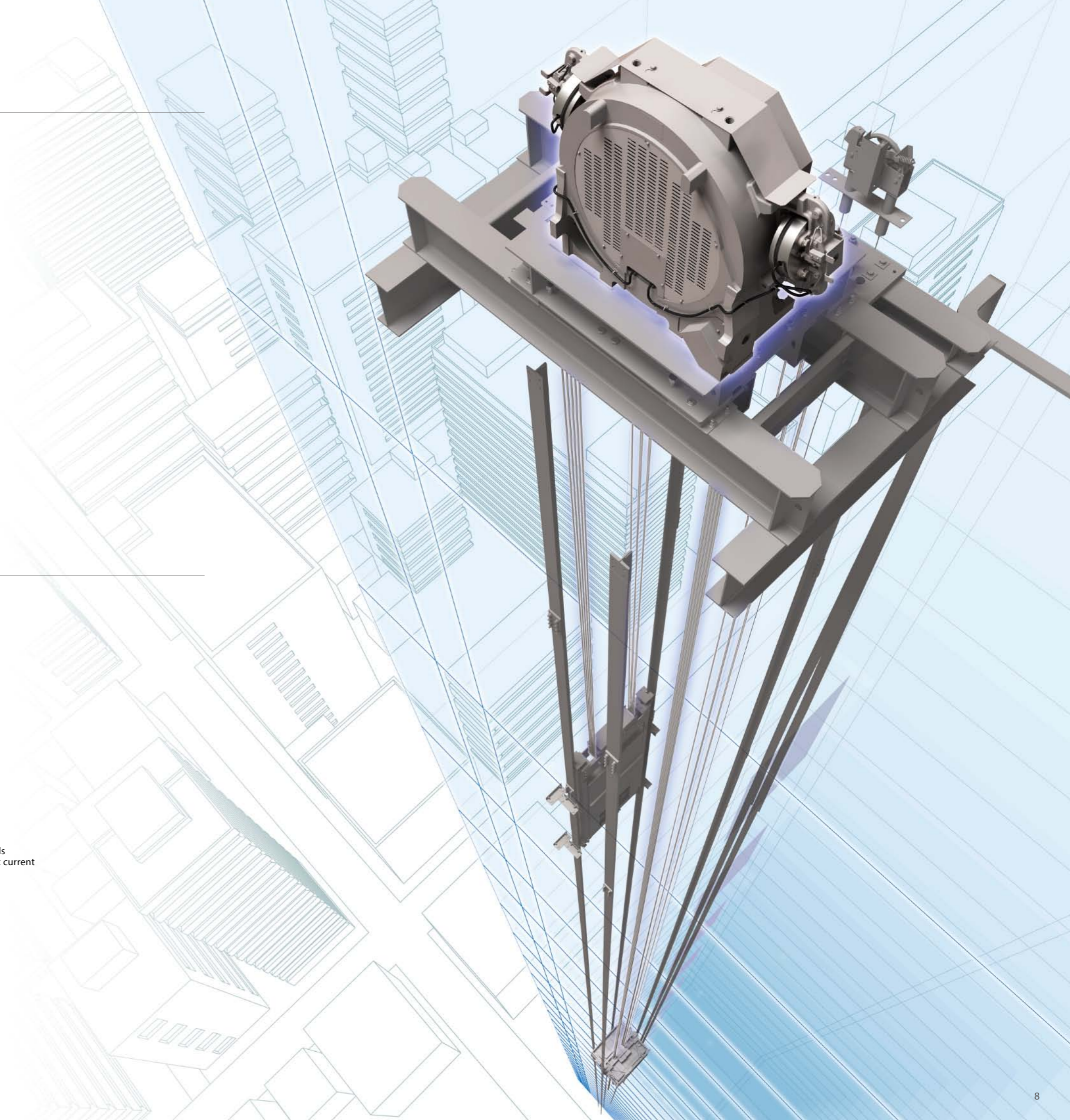

# Comfort

## Active Roller Guide\* (Optional)

The amount of lateral vibration generated by high-speed elevator cars is tremendous. As a world's first innovation in the industry, Mitsubishi Electric's Active Roller Guide technology reduces this vibration by approximately 50%. It works via an accelerometer that detects car vibration during operation, along with actuators that cancel the vibration through a controlled electromagnetic force. Mitsubishi Electric Active Roller Guides ensure a more comfortable ride than elevators employing conventional roller guides.

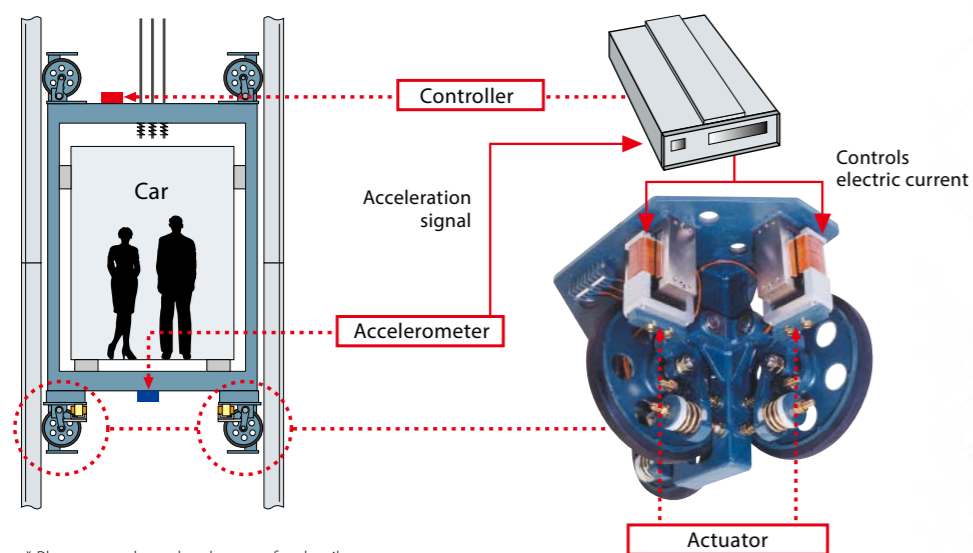

\* Please consult our local agents for details.



# Ecology

## Using Energy Wisely

Our long-term commitment to developing energy-efficient elevators has created systems and functions that make intelligent use of power.

### Milestones of Energy-saving Technologies in Elevator Development

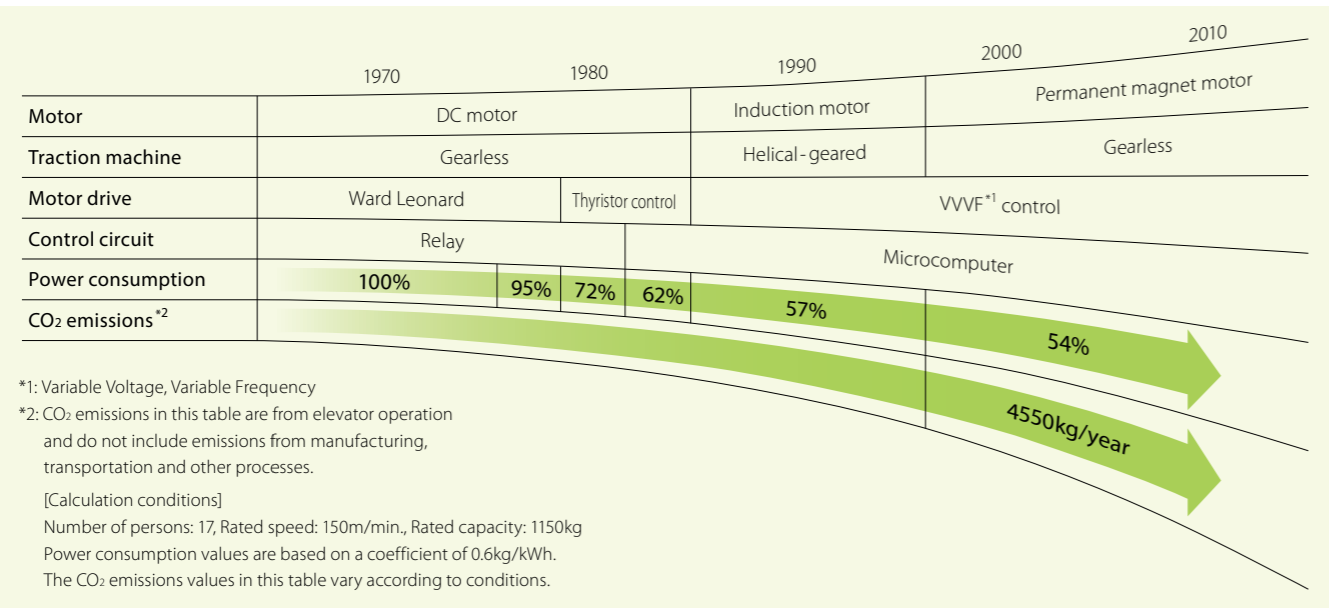

## Devices that Use Less Energy

### LED Lighting (Optional)

Used for ceiling lights and hall lanterns, LEDs boost the overall energy performance of the building. Furthermore, a long service life eliminates the need for frequent lamp replacement.

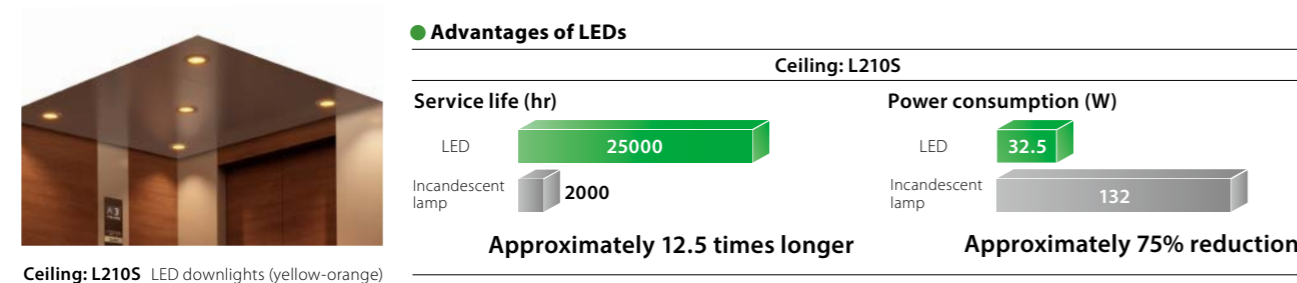

## Maximizing Operational Efficiency and Minimizing Energy Consumption

### Energy-saving Operation—Allocation Control (ESO-W) (ΣAI-2200C only)

This system selects the elevator in a group that best balances operational efficiency and energy consumption. Priority is given to operational efficiency during peak hours and energy efficiency during non-peak hours.

Through a maximum 10% reduction in energy consumption compared to our conventional system, this system allows building owners to cut energy costs without sacrificing passenger convenience.

# Safety

## Emergency Situations

### Emergency Operations\*

Enhance safety by adding emergency operation features which quickly respond to a power failure, fire or earthquake.

Power failure	<b>Mitsubishi Emergency Landing Device (MELD) (Optional)</b> Upon power failure, the car automatically moves to the nearest floor using a rechargeable battery to facilitate the safe evacuation of passengers.
	<b>Operation by Emergency Power Source — Automatic/Manual (OEPS) (Optional)</b> Upon power failure, predetermined cars use the building's emergency power supply to move to a specified floor and open the doors for passengers to evacuate. After all cars have arrived, the predetermined cars will resume normal operation.
Fire	<b>Fire Emergency Return (FER) (Optional)</b> When a key switch or the building's fire sensor is activated, all cars immediately return to a specified floor and open the doors to facilitate the safe evacuation of passengers.
	<b>Firefighters' Emergency Operation (FE) (Optional)</b> When the fire operation switch is activated, the car immediately returns to a predetermined floor. The car then responds only to car calls, which facilitates firefighting and rescue operations.
Earthquake	<b>Earthquake Emergency Return (EER-P/EER-S) (Optional)</b> When a primary and/or secondary wave seismic sensor is activated, all cars stop at the nearest floor and park there with the doors open to facilitate the safe evacuation of passengers.

\*Please refer to page 33 for details.

## For Safe Boarding

### Door Safety Devices

Our reliable safety devices ensure that the doors are clear to open and close. Depending on the type of sensor, the detection area differs.



Hall Motion Sensor (HMS) (optional)



Multi-beam Door Sensor (optional)

# Efficiency



## Destination Oriented Allocation System: DOAS (ΣAI-2200C only) (Optional)

### Allocating Passengers to Cars Depending on Destination Floors

When a passenger enters a destination floor at a hall, the hall operating panel immediately indicates which car will serve the floor. Because the destination floor is already registered, the passenger does not need to press a button in the car. Furthermore, dispersing passengers by destination prevents congestion in cars and minimizes waiting and traveling time. (Car destination floor indicator can be installed on the car operating panel to display floors to stop.\*1)

### Example of hall arrangement without hall lantern\*2

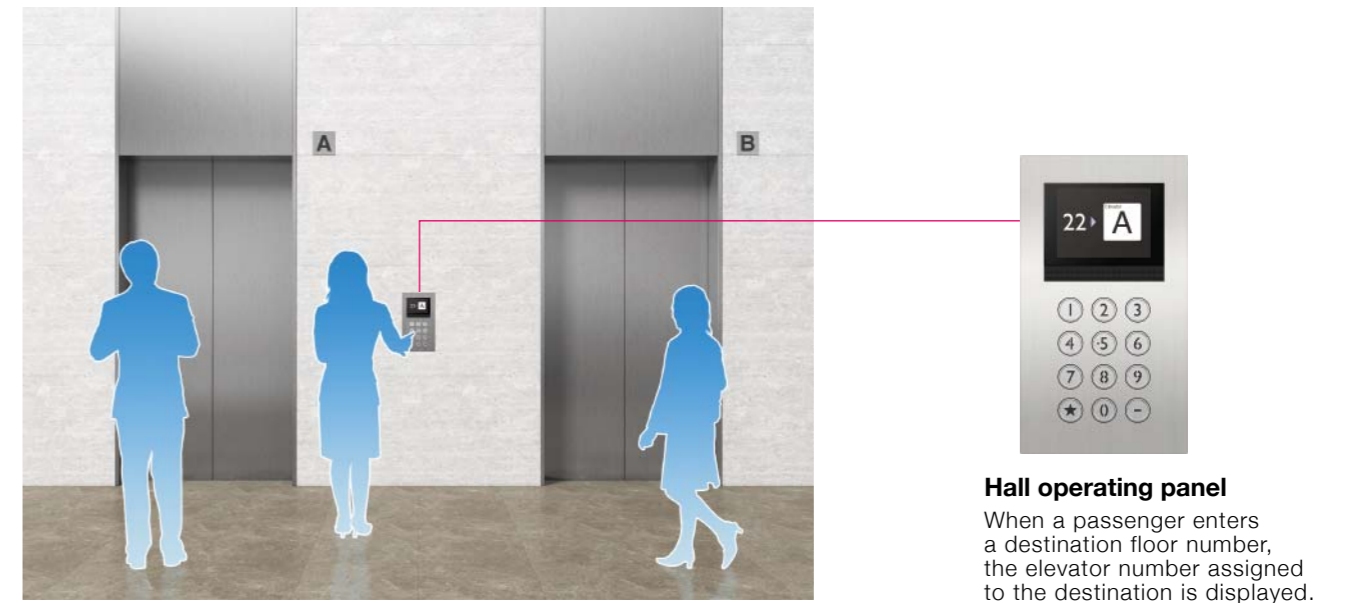

**Hall operating panel**  
When a passenger enters a destination floor number, the elevator number assigned to the destination is displayed.

Notes:  
\*1: Car destination floor indicator can be installed as an option.  
\*2: Hall arrangement with hall lantern is available as an option.

## Group Control Systems: ΣAI-22 and ΣAI-2200C

ΣAI-22 and ΣAI-2200C control multiple elevators optimally according to the building size.

Group control systems	Suitable building size	Number of cars in a group
ΣAI-22 system	Small to medium	3 to 4
ΣAI-2200C system	Large (especially buildings with dynamic traffic conditions)	3 to 8

### Performance

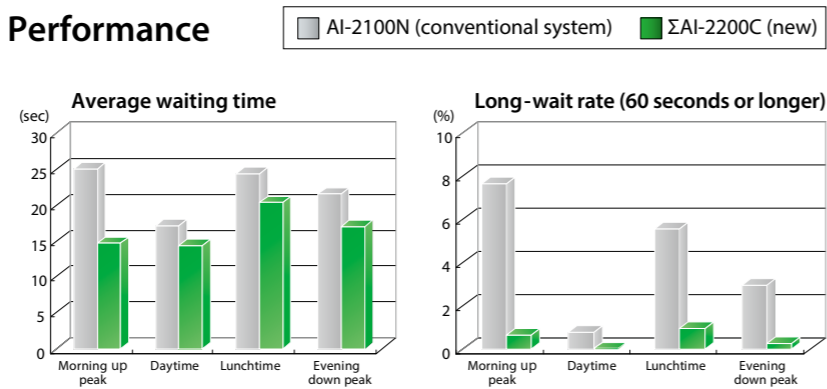

Improved: Max. 40%

Improved: Max. 80%

## Forecasting Near-future Hall Calls to Reduce Long Waits (ΣAI-2200C only)

### Cooperative Optimization Assignment

When a hall call is registered, the algorithm predicts near-future calls that could require long waits. Through evaluation of the registered hall call and the forecasted call, the best car is assigned. All cars work cooperatively for optimum operation.

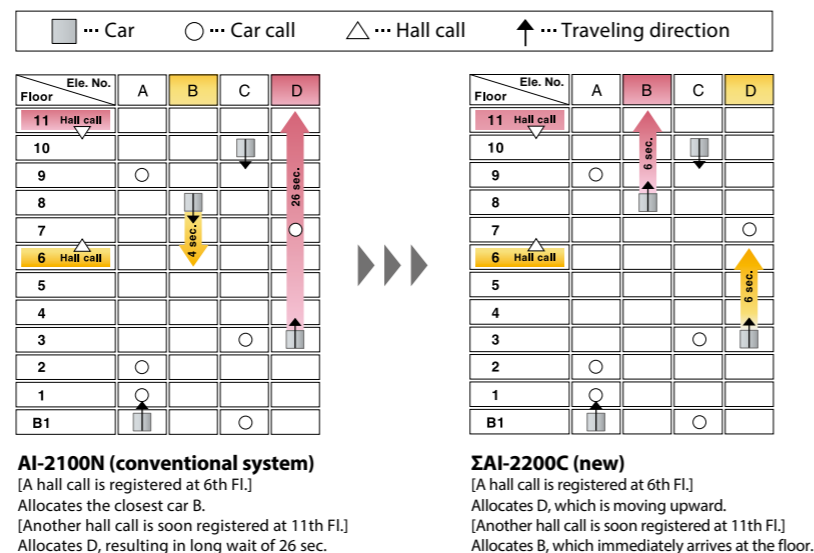

## Advantages of DOAS at Hall

**Without DOAS**

Passengers wait for cars wondering which car will arrive first. Once a car arrives, regardless of the destination, passengers rush to get into the car.

**With DOAS**

When passengers enter a destination floor at a hall, the hall operating panel indicates which elevator to take. As passengers proceed to the assigned elevator, the car is on its way and there is no hurry when the car arrives.



# Displays



## LCD Information Display\*1 (10.4- or 15-inch)

The cutting-edge LCD display delivers elevator information with stereoscopic direction arrows and animated pictures, and entertains the passengers with DVD playback/television (NTSC/PAL).



Example display of partial-screen animated picture



Car



Hall

## Colors

Select the best color from four popular and eye-catching background colors.

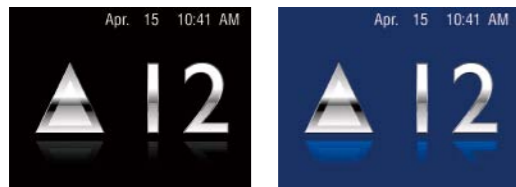

Urban black

Stylish blue

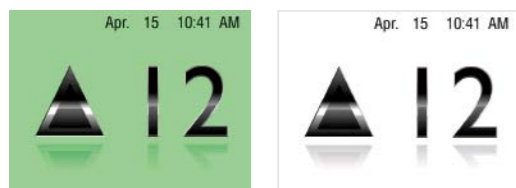

Fine green

Modern white

## Language

Standard elevator information, and date and time are available in English (US or UK), Chinese, Spanish, French or Japanese.



English (US or UK)

- Chinese 电梯关门 请远离电梯门
- Spanish Cerrando puertas Manténgase alejado de puerta
- French Fermeture des portes Eloignez vous des portes
- Japanese ドアが閉まります ドアから離れてください

Note :  
\*1. Please consult our local agents for the production terms, etc.

# IT Solutions

## Elevator Monitoring and Control System: MelEye

**MelEye** closely observes the operational status of elevators that handle continually changing passenger traffic. This allows building managers to rapidly respond to changing traffic patterns, thus optimizing the performance of elevators and maximizing the added value of the whole building. The application of the latest network technology has also greatly increased the number of controllable elevators, which minimizes the cost spent on facilities such as supervisory rooms and monitors.

**MelEye** is our solution to futuristic building traffic monitoring systems.

### Monitoring screens

MelEye's user-friendly screen shows the detailed operational status of the elevators in real time.

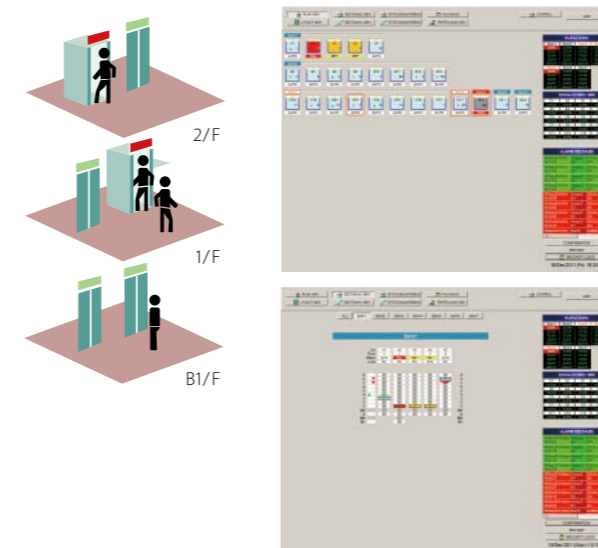

### Statistical information

The past fault logs of the elevators and escalators are recorded in addition to the operation logs of the computer.



### Remote control

A computer allows remote control of special and emergency operations.

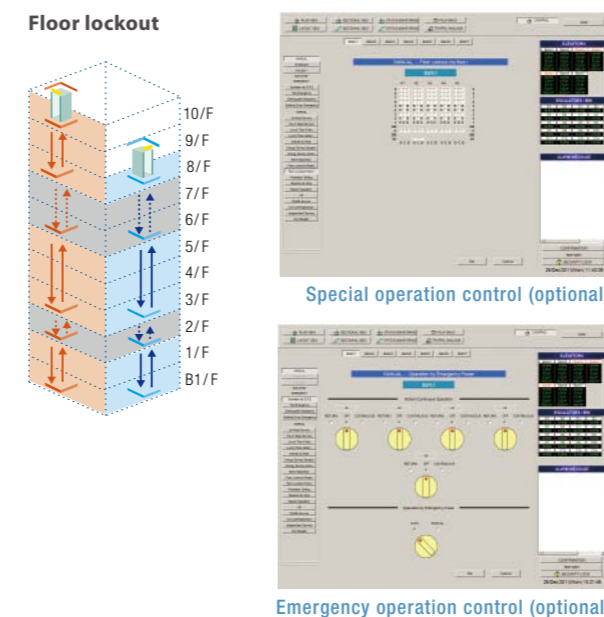

### Scheduling of special operations

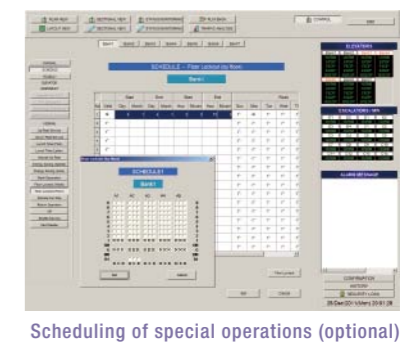



# Ceiling Designs

## Customized-1

Distinctive design using vaulted lighting and marble floor finish



### Car Design Example

- Walls ————— Decorative wooden panels
- Transom panel ——— SUS-M
- Doors ————— Colored (black) SUS-HE
- Front return panels — SUS-M
- Kickplate ————— SUS-HL
- Flooring ————— Marble
- Car operating panel — CBV3-D750 (faceplate: SUS-M)
- Handrails ————— YH-59M
- Mirror ————— YZ-55SN

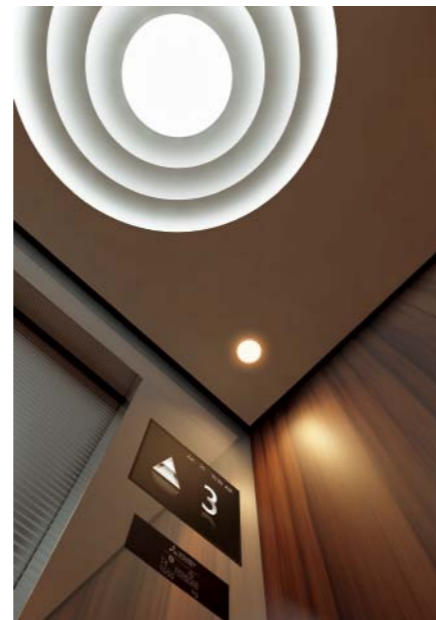

Ceiling: Painted steel sheet (Y033)  
Lighting: Central indirect lighting and downlights

## Customized-2

Indirect center lighting and downlights create a relaxing atmosphere



### Car Design Example

- Walls ————— Painted steel sheet
- Transom panel ——— Painted steel sheet
- Doors ————— Painted steel sheet
- Front return panels — SUS-HL
- Kickplate ————— SUS-HL
- Flooring ————— Marble
- Car operating panel — CBN4-C710
- Handrails ————— YH-59M
- Mirror ————— YZ-52A

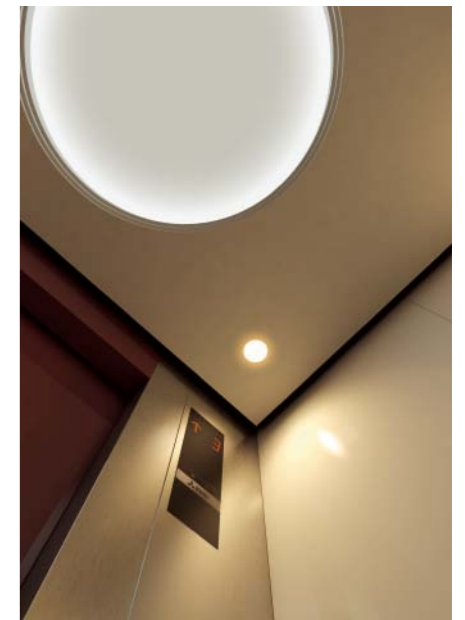

Ceiling: Painted steel sheet (Y033)  
Lighting: Central indirect lighting and downlights



# Ceiling Designs

L210

Sophisticated atmosphere created by downlights and shadows



## Car Design Example

- Walls ————— Pattern-printed steel sheet (CP111)
- Transom panel ——— Pattern-printed steel sheet (CP111)
- Doors ————— Pattern-printed steel sheet (CP101)
- Front return panels — SUS-HL
- Kickplate ————— SUS-HL
- Flooring ————— Durable vinyl tiles
- Car operating panel — CBV3-N730
- Handrails ————— YH-59S

Ceiling: Painted steel sheet (Y033)  
Lighting: Downlights (LEDs)



L210S Ceiling: SUS-HL  
Others: Same as L210

N300

Terraced design with illusion of increased ceiling height

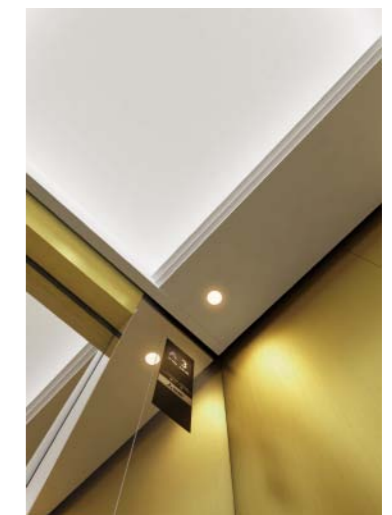

## Car Design Example

- Walls ————— Colored (gold) SUS-HL
- Transom panel ——— Colored (gold) SUS-HL
- Doors ————— SUS-M
- Front return panels — SUS-M
- Kickplate ————— Colored (gold) SUS-HL
- Flooring ————— Durable rubber tiles
- Car operating panel — CBV1-C730 (faceplate: SUS-M)
- Handrails ————— YH-59M

Ceiling: Painted steel sheet (Y033)  
Lighting: Central indirect lighting and downlights



N300S Ceiling: SUS-HL  
Others: Same as N300



# Ceiling Designs

N130

Light transmitted through exotic ceiling patterns



### Car Design Example

- Walls ————— Colored (bronze) SUS-HE (EPA-2)
- Transom panel ——— Colored (bronze) SUS-HE (EPA-2)
- Doors ————— Colored (bronze) SUS-HE (EPA-2)
- Front return panels — SUS-HL
- Kickplate ————— Colored (bronze) SUS-HL
- Flooring ————— Durable rubber tiles
- Car operating panel — CBV1-N710 (faceplate: SUS-M)
- Mirror ————— YZ-53A
- Handrails ————— YH-59M

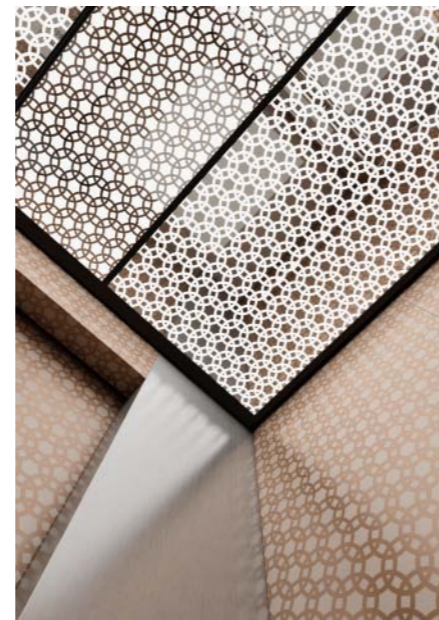

Ceiling: Milky white resin panels  
Lighting: Full lighting

N120

Gorgeous ceiling with lustrous translucent panels fused using refined geometric patterns

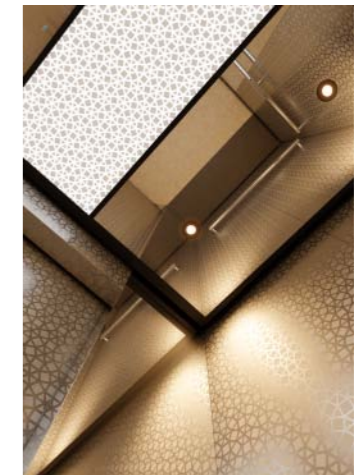

Ceiling: [Center] Milky white resin panel  
[Sides] Resin panels with mirrored surface  
Lighting: Central lighting and downlights

### Car Design Example

- Walls ————— SUS-HE (EPA-3)
- Transom panel ——— SUS-HE (EPA-3)
- Doors ————— SUS-HE (EPA-3)
- Front return panels — SUS-M
- Kickplate ————— SUS-HL
- Flooring ————— Durable rubber tiles
- Car operating panel — CBV5-N710
- Handrail ————— YH-59M

### Car Finishes Please refer to pages 31 and 32 for materials and colors.

Materials/Finishes	Walls	Transom panel	Doors	Front return panels	Kickplate	Flooring	Sill
Stainless-steel, hairline-finish (SUS-HL)	S	S	S	S	O		
Pattern-printed steel sheet	O	O	O				
Painted steel sheet	O	O	O	O	O*3		
Stainless-steel, hairline-finish with etched pattern*1 (SUS-HE)	O	O	O				
Colored stainless-steel, hairline-finish (colored SUS-HL)	O	O	O		O		
Colored stainless-steel, hairline-finish with etched pattern*2 (colored SUS-HE)	O	O	O				
Stainless-steel, mirror-finish (SUS-M)	O	O	O	O			
Aluminum					S		
Glass windows [1300(H)×200(W)/1300(H)×300(W)]				O			
See-through doors			O				
Durable vinyl tiles (2mm thick)						S	
Durable rubber tiles (3 or 6mm thick)						O	
Carpet, marble or granite (supplied by customer)						O	
Extruded hard aluminum							S
Stainless-steel							O

Note: S – Standard, O – Optional  
\*1 Etching pattern EPA-1~6 only. \*2 Etching pattern EPA-1~3 only.  
\*3 Only available in dark gray.



# Car Operating Panels

For front return panel

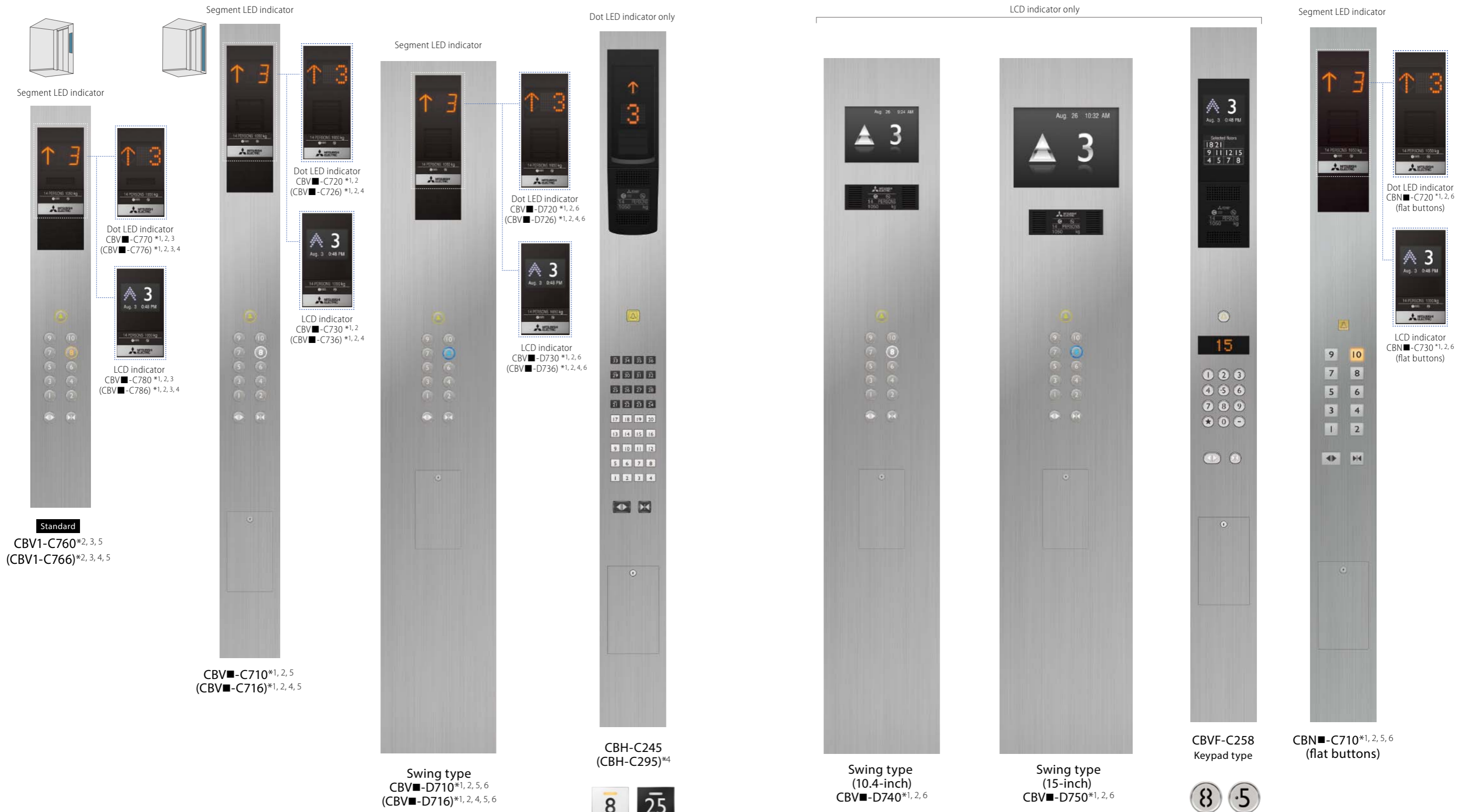

Notes:  
 \*1: The symbol ■ is replaced with a number representing the button type and illumination color (e.g., CBV1, CBV2, etc.). Please refer to page 27 for button types and illumination colors.  
 \*2: Faceplates with stainless-steel, mirror-finish are also available (optional). Please consult our local agents for details.  
 \*3: Maximum number of floors: 22 floors.  
 \*4: The types in parentheses ( ) show auxiliary car operating panels (optional). The design is slightly different from the above images. Please consult our local agents for further information such as installation location.  
 \*5: Some letters of the alphabet are not available. Please consult our local agents for details.  
 \*6: Please consult our local agents for the production terms, etc.

Numbers: Flat buttons  
 Star: Tactile button  
 (stainless-steel matte)



# Car Operating Panels

For side wall

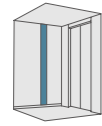

Segment LED indicator

Segment LED indicator

Dot LED indicator only

LCD indicator (5.7-inch) only



CBV-N710 \*1, 2, 4  
(CBV-N716) \*1, 2, 3, 4



Dot LED indicator  
CBV-N720 \*1, 2  
(CBV-N726) \*1, 2, 3



LCD indicator  
CBV-N730 \*1, 2  
(CBV-N736) \*1, 2, 3



CBV-N712 \*1, 2, 4  
(with alarm indication  
and tactile buttons for EN81-70)  
(CBV-N717) \*1, 2, 3, 4, 5



Dot LED indicator  
CBV-N722 \*1, 2  
(CBV-N727) \*1, 2, 3, 5

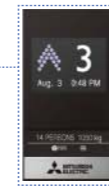

LCD indicator  
CBV-N732 \*1, 2  
(CBV-N737) \*1, 2, 3, 5

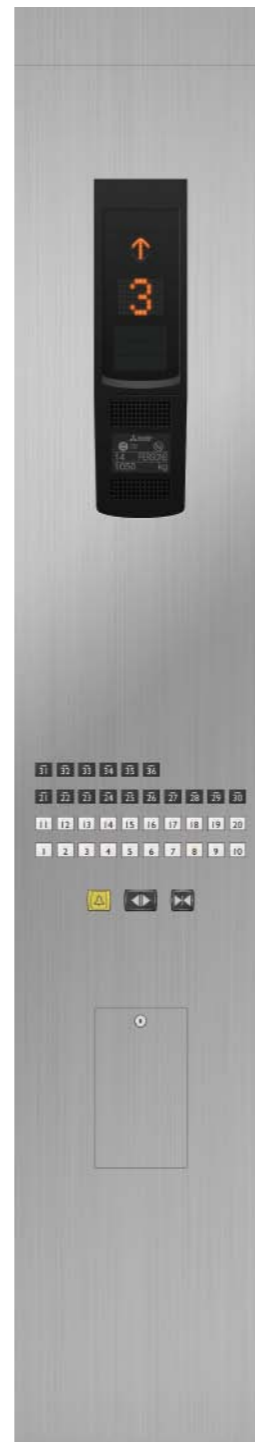

CBH-N215



Flat buttons (plastic)



CBVF-N228  
Keypad type

Car destination floor indicator



CBVF-N229S  
(with alarm indication  
and buttons for EN81-70)  
Keypad type



CBVF-N229L  
(with alarm indication  
and buttons for EN81-70)  
Keypad type



Numbers: Flat buttons  
Star: Tactile button  
(stainless-steel matte)

Notes:

\*1: The symbol ■ is replaced with a number representing the button type and illumination color (e.g., CBV1, CBV2, etc.).

Please refer to page 27 for button types and illumination colors.

\*2: Faceplates with stainless-steel, mirror-finish are also available (optional). Please consult our local agents for details.

\*3: The types in parentheses ( ) show auxiliary car operating panels (optional). The design is slightly different from the above images. Please consult our local agents for further information such as installation location.

\*4: Some letters of the alphabet are not available. Please consult our local agents for details.

\*5: Please consult our local agents for the production terms, etc.



# Hall Signal Fixtures

## Hall position indicators and buttons



## Hall buttons

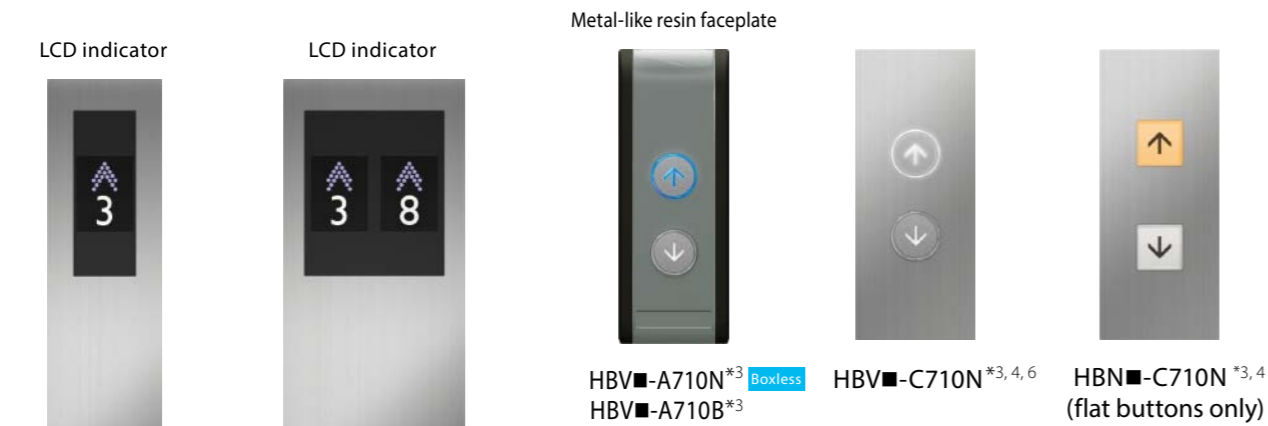

## No-entry indicators for EN81-73

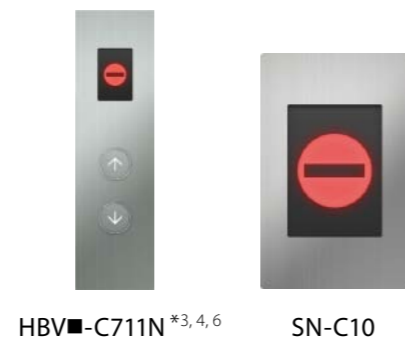

Notes:  
\*1: Some letters of the alphabet are not available. Please consult our local agents for details.  
\*2: Dot LED indicators are also available (optional). Please consult our local agents for details.  
\*3: The symbol ■ is replaced with a number representing the button type and illumination color (e.g., PIV1, PIV2, etc.). Please refer to page 27 for button types and illumination colors.  
\*4: Faceplates with stainless-steel, mirror-finish are also available (optional). Please consult our local agents for details.  
\*5: Only elevator status messages are available.  
\*6: These hall signal fixtures with tactile buttons are applicable to EN81-70 compliant elevators. However, PIV-C710N and PIV-C760N are available for 1C-2BC only.

## Hall lanterns

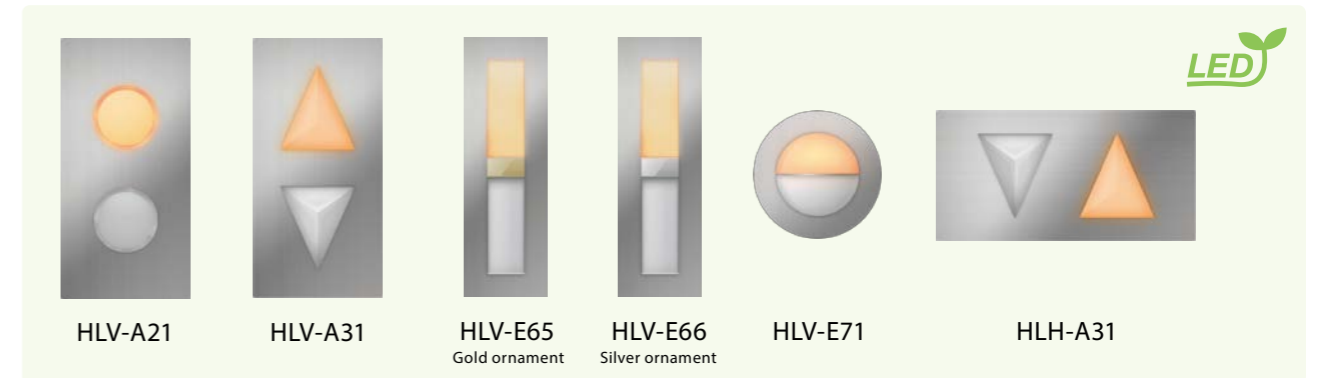

## LCD position indicator

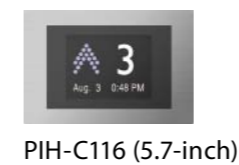

## LCD information displays

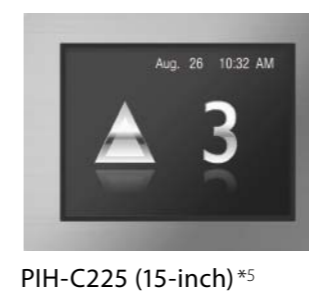

## Hall position indicators

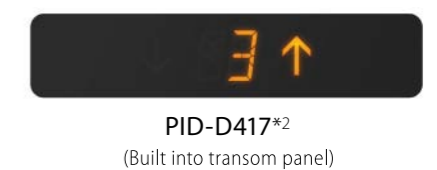
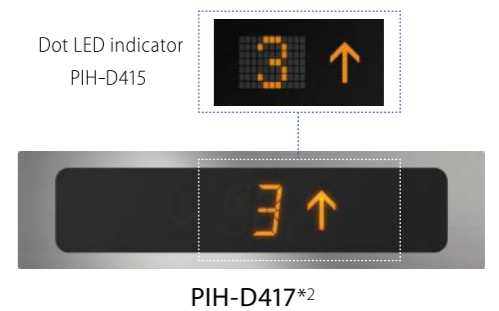

## Hall position indicator with lantern



## Cross-section of boxless fixtures

These hall signal fixtures can be easily mounted on the wall surface without having to cut into the wall to embed the back box.

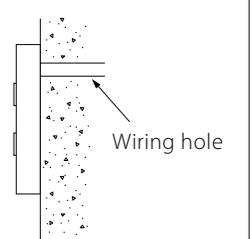



# Button Line-up

## Buttons accented with LED halo illumination

Illuminated characters (CBV type), arrows (PIV and HBV types) and halos attract user's attention. Tactile and flat buttons (stainless-steel with non-directional hairline-finish) are available in three illumination colors: yellow-orange, white and blue.

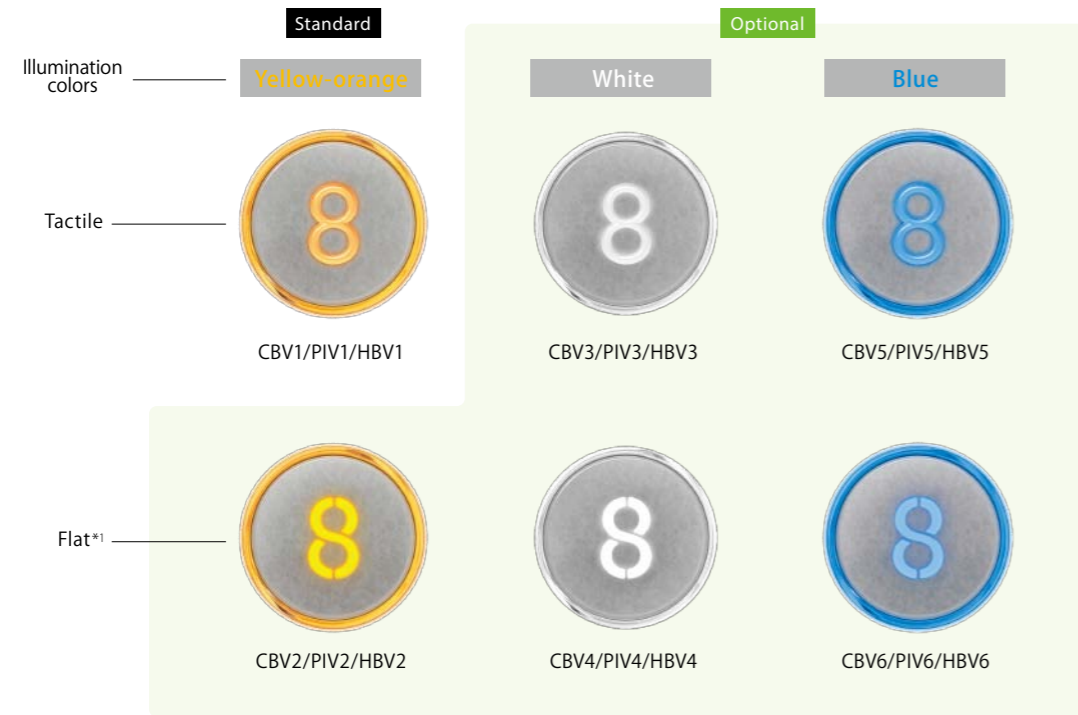

## Square buttons Optional

The entire buttons (excluding characters) are illuminated yellow-orange, white or blue.



# Interior

## Mirrors



## Handrails

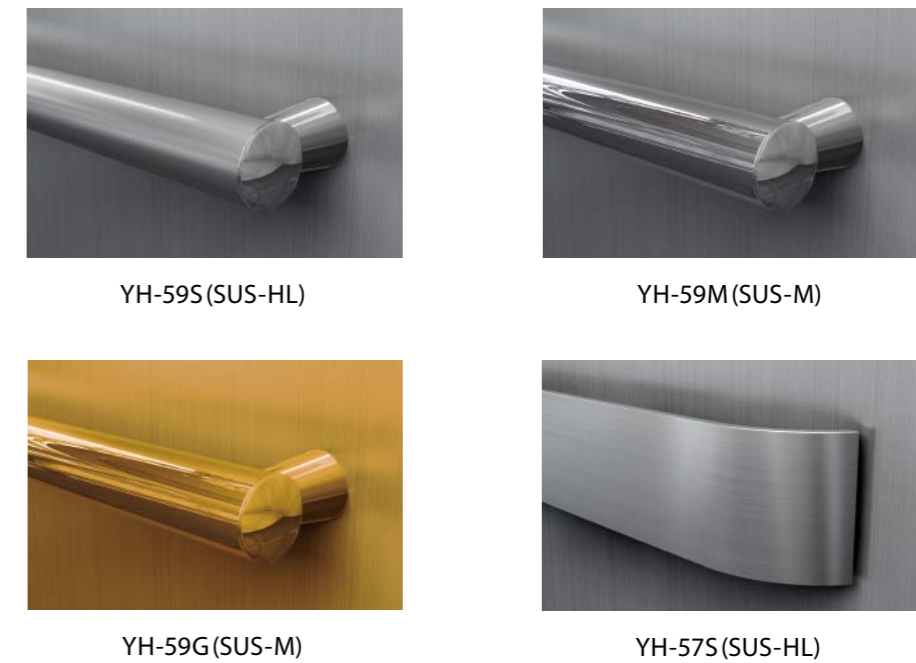

Note:  
\*1: Flat buttons are not applicable to regulation EN81-70.

Actual colors may differ slightly from those shown.  
Please refer to page 20 for the explanations of SUS-HL and SUS-M.

# Hall Designs

E-312 Splayed Jamb with Transom Panel  
E-212 Square Jamb with Transom Panel



### Hall Design Example of E-312

Jamb ———— SUS-HL  
Transom panel ———— Colored (black) SUS-HE  
Doors ———— Colored (black) SUS-HE  
Hall lantern ———— HLV-E71  
Hall button ———— HBV3-C710N

E-312 Splayed Jamb with Transom Panel  
E-212 Square Jamb with Transom Panel



### Hall Design Example of E-312

Jamb ———— SUS-HL  
Transom panel ———— SUS-HL  
Doors ———— See-through doors  
LCD information display ———— PIH-C225  
Hall button ———— HBV5-C710N

E-302 Splayed Jamb  
E-202 Square Jamb



### Hall Design Example of E-302

Jamb ———— SUS-HL  
Doors ———— Painted steel sheet (Y033)  
Hall lantern ———— HLV-E66  
Hall button ———— HBV1-C710N

E-102 Narrow Jamb Standard



### Hall Design Example

Jamb ———— SUS-HL  
Doors ———— SUS-HL  
Hall position indicator and button ———— PIV1-A710N Boxless

## Entrance Finishes Please refer to pages 31 and 32 for materials and colors.

Materials/Finishes	Jamb	Transom panel	Doors	Sill
Stainless-steel, hairline-finish (SUS-HL)	S	O	S	
Painted steel sheet	O	O	O	
Stainless-steel, hairline-finish with etched pattern (SUS-HE)		O	O	
Stainless-steel, mirror-finish (SUS-M)			O	
Glass windows [1300(H)×200(W)/1300(H)×300(W)]			O	
See-through doors			O	
Extruded hard aluminum				S
Stainless-steel				O

Note: S – Standard, O – Optional



# Materials and Colors

## [Car] Walls, doors and transom panel

**Colored stainless-steel, hairline-finish**

Gold Bronze

**Etching patterns (gold or bronze)**  
\*Please refer to the etching finish pattern book, EFA1, for details.

EPA-1 EPA-2 EPA-3

**Pattern-printed steel sheet**

CP23 CP101 CP111 CP121 CP141

Non-etched surface  
Etched surface

## Ceiling

**Painted steel sheet**  
(L210, N300, customized-1, customized-2 only)

Y033

Y055

Y073

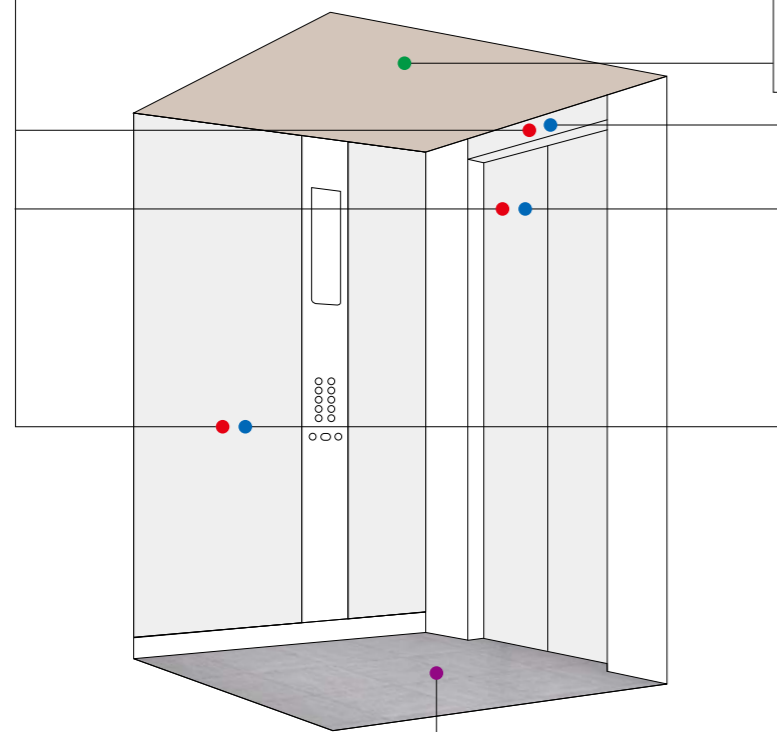

## Flooring

**Durable vinyl tiles**

PR801 PR803 PR810 PR812

## [Car] Walls, doors and transom panel [Hall] Doors, transom panel and jamb

**Stainless-steel**

Hairline-finish Mirror-finish (not applicable to the hall transom panel and jamb)

**Etching patterns (stainless-steel)**  
\*Not applicable to the jamb; please refer to the etching finish pattern book, EFA1, for details.

EPA-1 EPA-2 EPA-3 EPA-4 EPA-5 EPA-6

Non-etched surface  
Etched surface

**Painted finish**

Y002 Y004 Y006 Y014 Y016 Y033

Y051 Y054 Y055 Y071 Y116

## [Hall] Doors and transom panel

**Etching patterns** \*Please refer to the etching finish pattern book, EF4, for details.

EP-A-004 EP-A-011 EP-A-021 EP-B-009 EP-D-006 EP-F-004

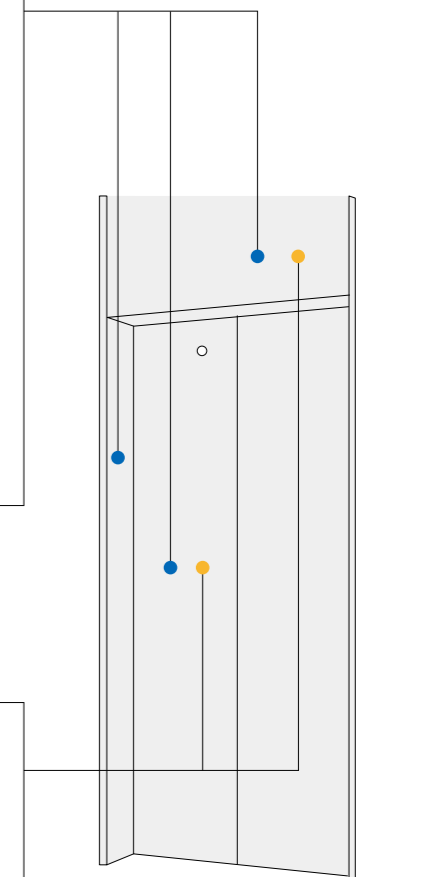

# Features (1/2)

Feature	Description	1C to 2C 2BC	3C & 4C ΣAI-22	3C to 8C ΣAI-2200C
<b>EMERGENCY OPERATIONS AND FEATURES</b>				
Mitsubishi Emergency Landing Device (MELD)	Upon power failure, a car equipped with this function automatically moves and stops at the nearest floor using a rechargeable battery, and the doors open to facilitate the safe evacuation of passengers. (Maximum allowable floor-to-floor distance is 10 meters.)	⊙	⊙	⊙
Operation by Emergency Power Source — Automatic/Manual (OEPS)	Upon power failure, predetermined cars use the building's emergency power supply to move to a specified floor, where the doors then open to facilitate the safe evacuation of passengers. After all cars have arrived, predetermined cars resume normal operation.	⊙	⊙	⊙
Fire Emergency Return (FER)	Upon activation of a key switch or the building's fire alarm, all calls are canceled, all cars immediately return to a specified evacuation floor and the doors open to facilitate the safe evacuation of passengers.	⊙	⊙	⊙
Firefighters' Emergency Operation (FE)	During a fire, when the fire operation switch is activated, the car calls of a specified car and all hall calls are canceled and the car immediately returns to a predetermined floor. The car then responds only to car calls, which facilitates firefighting and rescue operations.	⊙	⊙	⊙
Earthquake Emergency Return (EER-P/EER-S)	Upon activation of primary and/or secondary wave seismic sensors, all cars stop at the nearest floor, and park there with the doors open to facilitate the safe evacuation of passengers.	⊙	⊙	⊙
Supervisory Panel (WP)	Each elevator's status and operation can be remotely monitored and controlled through a panel installed in a building's supervisory room, etc.	⊙	⊙	⊙#1
MelEye (WP-W) Mitsubishi Elevators & Escalators Monitoring and Control System	Each elevator's status and operation can be monitored and controlled using an advanced web-based technology which provides an interface through personal computers. Special optional features such as preparation of traffic statistics and analysis are also available.	⊙	⊙	⊙
Emergency Car Lighting (ECL)	Car lighting which turns on immediately when power fails, providing a minimum level of lighting within the car. (Choice of dry-cell battery or trickle-charge battery.)	⊙	⊙	⊙
<b>DOOR OPERATION FEATURES</b>				
Door Sensor Self-diagnosis (DODA)	Failure of non-contact door sensors is checked automatically, and if a problem is diagnosed, the door-close timing is delayed and the closing speed is reduced to maintain elevator service and ensure passenger safety.	Ⓢ	Ⓢ	Ⓢ
Automatic Door Speed Control (DSAC)	Door load on each floor, which can depend on the type of hall doors, is monitored to adjust the door speed, thereby making the door speed consistent throughout all floors.	Ⓢ	Ⓢ	Ⓢ
Automatic Door-open Time Adjustment (DOT)	The time doors are open is automatically adjusted depending on whether the stop was called from the hall or the car, to allow smooth boarding of passengers or loading of baggage.	—	—	Ⓢ
Reopen with Hall Button (ROHB)	Closing doors can be reopened by pressing the hall button corresponding to the traveling direction of the car.	Ⓢ	Ⓢ	Ⓢ
Repeated Door-close (RDC)	Should an obstacle prevent the doors from closing, the doors will repeatedly open and close until the obstacle is cleared from the doorway.	Ⓢ	Ⓢ	Ⓢ
Door Nudging Feature — With Buzzer (NDG)	A buzzer sounds and the doors slowly close when they have remained open for longer than the preset period. With AAN-B or AAN-G, a beep and voice guidance sound instead of the buzzer.	Ⓢ	Ⓢ	Ⓢ
Door Load Detector (DLD)	When excessive door load has been detected while opening or closing, the doors immediately reverse.	Ⓢ	Ⓢ	Ⓢ
Safety Door Edge (SDE)	One side (2S doors) Both sides (CO & 2CO doors)	Sensitive door edges detect passengers or objects during door closing.	Ⓢ	Ⓢ
Safety Ray (SR)	One or two infrared-light beams cover the full width of the doors as they close to detect passengers or objects. (Cannot be combined with the Multi-beam Door Sensor feature.)			
Extended Door-open Button (DKO-TB)	When the button inside a car is pressed, the doors remain open longer to allow loading and unloading of baggage, a stretcher, etc.	⊙	⊙	—
Electronic Doorman (EDM)	Door open time is minimized using the Safety Ray (SR) or Multi-beam Door Sensor feature that detects passengers boarding or exiting.	⊙	⊙	⊙
Multi-beam Door Sensor	Multiple infrared-light beams cover a door height of approximately 1800mm to detect passengers or objects as the doors close. (Cannot be combined with the SR feature.)	⊙	⊙	⊙#2
Hall Motion Sensor (HMS)	Infrared-light is used to scan a 3D area near the open doors to detect passengers or objects.	⊙	⊙	⊙
<b>OPERATIONAL AND SERVICE FEATURES</b>				
Safe Landing (SFL)	If a car has stopped between floors due to some equipment malfunction, the controller checks the cause, and if it is considered safe to move the car, the car moves to the nearest floor at a low speed and the doors open.	Ⓢ	Ⓢ	Ⓢ
Next Landing (NXL)	If the elevator doors do not open fully at a destination floor, the doors close, and the car automatically moves to the next or nearest floor where the doors open.	Ⓢ	Ⓢ	Ⓢ
Continuity of Service (COS)	A car which is experiencing trouble is automatically withdrawn from group control operation to maintain overall group performance.	Ⓢ†	Ⓢ	Ⓢ

Feature	Description	1C to 2C 2BC	3C & 4C ΣAI-22	3C to 8C ΣAI-2200C
Overload Holding Stop (OLH)	A buzzer sounds to alert the passengers that the car is overloaded. The doors remain open and the car will not leave that floor until enough passengers exit the car.	Ⓢ	Ⓢ	Ⓢ
Automatic Hall Call Registration (FSAT)	If one car cannot carry all waiting passengers because it is full, another car will automatically be assigned for the remaining passengers.	Ⓢ	Ⓢ	Ⓢ
Car Call Canceling (CCC)	When a car has responded to the final car call in one direction, the system regards remaining calls in the other direction as mistakes and clears them from the memory.	Ⓢ	Ⓢ	Ⓢ
Car Fan Shut Off — Automatic (CFO-A)	If there are no calls for a specified period, the car ventilation fan automatically turns off to conserve energy.	Ⓢ	Ⓢ	Ⓢ
Car Light Shut Off — Automatic (CLO-A)	If there are no calls for a specified period, the car lighting automatically turns off to conserve energy.	Ⓢ	Ⓢ	Ⓢ
Backup Operation for Group Control Microprocessor (GCBK)	An operation by car controllers which automatically maintains elevator operation in the event that a microprocessor or transmission line in the group controller has failed.	Ⓢ†	Ⓢ	Ⓢ
Independent Service (IND)	Exclusive operation where a car is withdrawn from group control operation for independent use, such as maintenance or repair, and responds only to car calls.	Ⓢ	Ⓢ	Ⓢ
Automatic Bypass (ABP)	A fully-loaded car bypasses hall calls in order to maintain maximum operational efficiency. (Optional feature when the operation system is 1C-2BC.)	Ⓢ	Ⓢ	Ⓢ
False Call Canceling — Automatic (FCC-A)	If the number of registered car calls does not correspond to the car load, all calls are canceled to avoid unnecessary stops.	Ⓢ	Ⓢ	Ⓢ
False Call Canceling — Car Button Type (FCC-P)	If a wrong car button is pressed, it can be canceled by quickly pressing the same button again twice.	Ⓢ	Ⓢ	Ⓢ
High Accuracy Landing Feature (HARL)	The car landing level is adjusted to a high level of precision in order to ensure a landing accuracy of ±5mm under any conditions.	Ⓢ	Ⓢ	Ⓢ
Out-of-service — Remote (RCS)	With a key switch on the supervisory panel, etc., a car can be called to a specified floor after responding to all car calls, and then automatically be taken out of service.	⊙	⊙	⊙
Secret Call Service (SCS-B)	To enhance security, car calls for desired floors can be registered only by entering secret codes using the car buttons on the car operating panel. This function is automatically deactivated during emergency operation.	⊙	⊙	⊙
Non-service to Specific Floors — Car Button Type (NS-CB)	To enhance security, service to specific floors can be disabled using the car operating panel. This function is automatically deactivated during emergency operation.	⊙	⊙	⊙
Non-service to Specific Floors — Switch/Timer Type (NS/NS-T)	To enhance security, service to specific floors can be disabled using a manual or timer switch. This function is automatically deactivated during emergency operation.	⊙	⊙	⊙
Out-of-service by Hall Key Switch (HOS/HOS-T)	For maintenance or energy-saving measures, a car can be taken out of service temporarily with a key switch (with or without a timer) mounted in a specified hall.	⊙	⊙	⊙
Return Operation (RET)	Using a key switch on the supervisory panel, a car can be withdrawn from group control operation and called to a specified floor. The car will park on that floor with the doors open, and not accept any calls until independent operations begin.	⊙	⊙	⊙
Attendant Service (AS)	Exclusive operation where an elevator can be operated using the buttons and switches located in the car operating panel, allowing smooth boarding of passengers or loading of baggage.	⊙	⊙	⊙
Motor Drive Mix (MDX)	The rate of car acceleration and deceleration is automatically increased according to the car load to reduce passenger waiting and travel time.	—	⊙	⊙
<b>GROUP CONTROL FEATURES</b>				
Car Travel Time Evaluation	Cars are allocated to hall calls by considering the number of car calls which will reduce passenger waiting time in each hall and the travel time of each car.	—	Ⓢ	Ⓢ
Car Allocation Tuning (CAT)	The number of cars allocated or parked on crowded floors is controlled not just according to the conditions on those crowded floors but also the operational status of each car and the traffic on each floor.	—	—	Ⓢ
Cooperative Optimization Assignment	The system predicts a potential hall call which could cause longer waiting time. Car assignment is performed considering not only current and new calls but also near-future calls.	—	—	Ⓢ
Distinction of Traffic Flow with Neural Networks (NN)	Traffic flows in a building are constantly monitored using neural network technology, and the optimum operational pattern, such as the Lunchtime Service (LTS) or Up Peak Service (UPS) feature, is selected or canceled accordingly at the appropriate time.	—	—	Ⓢ
Dynamic Rule-set Optimizer (DRO)	Traffic flows in a building are constantly predicted using neural network technology, and an optimum rule-set for group control operations is selected through real-time simulations based on prediction results.	—	—	Ⓢ
Expert System and Fuzzy Logic	Artificial expert knowledge, which has been programmed using "expert system" and "fuzzy logic", is applied to select the ideal operational rule which maximizes the efficiency of group control operations.	—	Ⓢ	Ⓢ
Peak Traffic Control (PTC)	A floor which temporarily has the heaviest traffic is served with higher priority over other floors, but not to the extent that it interferes with the service to other floors.	—	Ⓢ	Ⓢ

Notes: 1C-2BC (1-car selective collective) - Standard, 2C-2BC (2-car group control system) - Optional  
 ΣAI-22 (3 to 4-car group control system) - Optional, ΣAI-2200C (3 to 8-car group control system) - Optional  
 Ⓢ=Standard ⊙=Optional †=Not applicable to 1-car 2BC system — = Not applicable  
 #1=Please consult our local agents for the production terms, etc.  
 #2=When the DOAS is applied, the Safety Ray (SR) or Multi-beam Door Sensor feature should be installed.



# Features (2/2)

Feature	Description	1C to 2C 2BC	3C & 4C ΣAI-22	3C to 8C ΣAI-2200C
<b>GROUP CONTROL FEATURES</b>				
Psychological Waiting Time Evaluation	Cars are allocated according to the predicted psychological waiting time for each hall call. The rules evaluating psychological waiting time are automatically changed in a timely manner in response to actual service conditions.	—	Ⓢ	Ⓢ
Strategic Overall Spotting (SOHS)	To reduce passenger waiting time, cars which have finished service are automatically directed to positions where they can respond to predicted hall calls as quickly as possible.	Ⓢ†	Ⓢ	Ⓢ
Energy-saving Operation — Allocation Control (ESO-W)	The system selects the elevator that best balances operational efficiency and energy consumption according to each elevator's current location and passenger load as well as predicted congestion levels throughout the day.	—	—	Ⓢ
Energy-saving Operation — Power Reduction during Off-peak (ESO-A)	To save energy, some elevators are automatically put into sleep mode if there are no calls for a specified period.	—	Ⓢ#1	Ⓢ#1
Energy-saving Operation — Speed Control (ESO-V)	To save energy, the car speed is automatically reduced to some extent, but not so much that it adversely affects passenger waiting time.	—	Ⓢ#1	Ⓢ
Destination Oriented Allocation System (DOAS)	When a passenger enters a destination floor at a hall, the hall operating panel indicates which car will serve the floor. The passenger does not need to press a button in the car. Dispersing passengers by destination prevents congestion in the cars and minimizes waiting and traveling time. (Cannot be combined with some features. Please consult our local agents for details.)	—	—	Ⓢ#2
Intense Up Peak (IUP)	To maximize transport efficiency, an elevator bank is divided into two groups of cars to serve upper and lower floors separately during up peak. In addition, the number of cars to be allocated, the timing of car allocation to the lobby floor, the timing of door closing, etc., are controlled based on predicted traffic data.	—	—	Ⓢ
Up Peak Service (UPS)	Controls the number of cars to be allocated to the lobby floor, as well as the car allocation timing, in order to meet increased demands for upward travel from the lobby floor during office starting time, hotel check-in time, etc., and minimize passenger waiting time.	—	Ⓢ	Ⓢ
Down Peak Service (DPS)	Controls the number of cars to be allocated and the timing of car allocation in order to meet increased demands for downward travel during office leaving time, hotel check-out time, etc., to minimize passenger waiting time.	—	Ⓢ	Ⓢ
Main Floor Parking (MFP)	An available car always parks on the main (lobby) floor with the doors open (or closed only in China).	Ⓢ	Ⓢ	Ⓢ
Forced Floor Stop (FFS)	All cars in a bank automatically make a stop at a predetermined floor on every trip without being called.	Ⓢ	Ⓢ	Ⓢ
Special Floor Priority Service (SFPS)	Special floors, such as floors with VIP rooms or executive rooms, are given higher priority for car allocation when a call is made on those floors. (Cannot be combined with hall position indicators.)	—	Ⓢ#1	Ⓢ
Closest-car Priority Service (CNPS)	A function to give priority allocation to the car closest to the floor where a hall call button has been pressed, or to reverse the closing doors of the car closest to the pressed hall call button on that floor. (Cannot be combined with hall position indicators.)	—	Ⓢ#1	Ⓢ
Light-load Car Priority Service (UCPS)	When traffic is light, empty or lightly-loaded cars are given higher priority to respond to hall calls in order to minimize passenger travel time. (Cannot be combined with hall position indicators.)	—	Ⓢ#1	Ⓢ
Special Car Priority Service (SCPS)	Special cars, such as observation elevators and elevators with basement service, are given higher priority to respond to hall calls. (Cannot be combined with hall position indicators.)	—	Ⓢ#1	Ⓢ
Congested-floor Service (CFS)	The timing of car allocation and the number of cars to be allocated to floors where meeting rooms or ballrooms exist and the traffic intensifies for short periods of time are controlled according to the detected traffic density data for those floors.	—	Ⓢ#1	Ⓢ
Bank-separation Operation (BSO)	Hall buttons and the cars called by each button can be divided into several groups for independent group control operation to serve special needs or different floors.	—	Ⓢ	Ⓢ
VIP Operation (VIP-S)	A specified car is withdrawn from group control operation for VIP service operation. When activated, the car responds only to existing car calls, moves to a specified floor and parks there with the doors open. The car then responds only to car calls.	Ⓢ#1	Ⓢ	Ⓢ
Lunchtime Service (LTS)	During the first half of lunchtime, calls for a restaurant floor are served with higher priority, and during the latter half, the number of cars allocated to the restaurant floor, the allocation timing for each car and the door opening and closing timing are all controlled based on predicted data.	—	Ⓢ	Ⓢ
Main Floor Changeover Operation (TFS)	This feature is effective for buildings with two main (lobby) floors. The floor designated as the "main floor" in a group control operation can be changed as necessary using a manual switch.	Ⓢ	Ⓢ	Ⓢ

Feature	Description	1C to 2C 2BC	3C & 4C ΣAI-22	3C to 8C ΣAI-2200C
<b>SIGNAL AND DISPLAY FEATURES</b>				
Basic Announcement (AAN-B)	A synthetic voice (and/or buzzer) alerts passengers inside a car that elevator operation has been temporarily interrupted by overloading or a similar cause. (Voice available only in English.)	Ⓢ	Ⓢ	Ⓢ
Flashing Hall Lantern (FHL)	A hall lantern, which corresponds to a car's service direction, flashes to indicate that the car will soon arrive.	Ⓢ	Ⓢ	Ⓢ
Car Arrival Chime	Car (AECC)	Ⓢ	Ⓢ	—
	Hall (AECH)	Ⓢ	Ⓢ	Ⓢ
Sonic Car Button — Click Type (ACB)	A click-type car button which emits electronic beep sound when pressed to indicate that the call has been registered.	Ⓢ	Ⓢ	Ⓢ
Immediate Prediction Indication (AIL)	When a passenger has registered a hall call, the best car to respond to that call is immediately selected, the corresponding hall lantern lights up and a chime sounds once to indicate which doors will open.	—	—	Ⓢ
Second Car Prediction (TCP)	When a hall is crowded to the extent that one car cannot accommodate all waiting passengers, a hall lantern will light up to indicate the next car to serve the hall.	—	—	Ⓢ
Voice Guidance System (AAN-G)	Information on elevator service such as the current floor or service direction is given to the passengers inside a car. (Voice guidance available only in English.)	Ⓢ	Ⓢ	Ⓢ
Auxiliary Car Operating Panel (ACS)	An additional car control panel which can be installed for large-capacity elevators, heavy-traffic elevators, etc.	Ⓢ	Ⓢ	Ⓢ
Intercommunication System (ITP)	A system which allows communication between passengers inside a car and the building personnel.	Ⓢ	Ⓢ	Ⓢ
Car LCD Position Indicator (CID-S)	This 5.7-inch LCD for car operating panels shows the date and time, car position, travel direction and elevator status messages.	Ⓢ	Ⓢ	Ⓢ
Hall LCD Position Indicator (HID-S)	This 5.7-inch LCD for elevator halls shows the date and time, car position, travel direction and elevator status messages.	Ⓢ#1	Ⓢ#1	—
Car Information Display (CID)	This LCD (10.4- or 15-inch) for car front return panels shows the date and time, car position, travel direction and elevator status messages. In addition, customized video images can be displayed in full-screen or partial-screen formats.	Ⓢ#1	Ⓢ#1	Ⓢ#1
Hall Information Display (HID)	This LCD (10.4- or 15-inch) for elevator halls shows the date and time, car position, travel direction and elevator status messages. In addition, customized video images can be displayed in full-screen or partial-screen formats.	Ⓢ#1	Ⓢ#1	—

Notes: 1C-2BC (1-car selective collective) - Standard, 2C-2BC (2-car group control system) - Optional  
 ΣAI-22 (3 to 4-car group control system) - Optional, ΣAI-2200C (3 to 8-car group control system) - Optional  
 Ⓢ=Standard Ⓢ=Optional †=Not applicable to 1-car 2BC system —= Not applicable  
 #1=Please consult our local agents for the production terms, etc.  
 #2=When the DOAS is applied, the Safety Ray (SR) or Multi-beam Door Sensor feature should be installed.  
 DOAS cannot be combined with BSO, VIP-S, IUP, UPS, TFS, FSAT, STH, AS, FCC-A, FHC-P, HE-B, DKO-TB, HID, AIL, TCP, ABP, 1D-2G, 2D-2G or HID-S feature.

# Specifications

## Capacity and Speed\*1

Rated capacity (kg)	Number of persons	Rated speed (m/sec)											Mitsubishi Electric Standard *2	EN81-1
		2.0	2.5	3.0	3.5	4.0	5.0	6.0	7.0	8.0	9.0	10.0		
750	10	●	●	●	●	●	●	●	○	○	○	○		☆
	11												☆	
900	12	●	●	●	●	●	●	●	○	○	○	○		☆
	13												☆	
1000	15												☆	
1050	14	●	●	●	●	●	●	○	○	○	○		☆	
1150	17	●	●	●	●	●	●	○	○	○	○		☆	
1200	16	●	●	●	●	●	●	○	○	○	○		☆	
1350	18	●	●	●	●	●	●	○	○	○	○		☆	
	20											☆		
1600	21	●	●	●	●	●	●	○	○	○	○		☆	
	24											☆		
1800	24	●	●	●	●	●	●	○	○	○	○		☆	
	27	●	●	●	●	●	●	○	○	○	○	☆		
2000	26	●	●	●	●	●	●	○	○	○	○		☆	
	30	●	●	●	●	●	●	○	○	○	○	☆		
2250	30	○	○	○	○	○	○	○	○	○	○		☆	
	34	○	○	○	○	○	○	○	○	○	○	☆		
2500	33	○	○	○	○	○							☆	
	38	○	○	○	○	○						☆		
3000	40	○	○	○	○	○							☆	
	46	○	○	○	○	○						☆		

Notes:  
 \*1: The symbol ○ shown in the table indicates that a technical inquiry is required.  
 The symbol ● shown in the table indicates that a technical inquiry is required depending on conditions.  
 \*2: Based on, but not fully complying with the Building Standard Law of Japan, 2009.

## Specifications\*3

Rated speed (m/sec)	2.0	2.5	3.0	3.5	4.0	5.0	6.0	7.0	8.0	9.0	10.0	
Maximum number of stops	64							Please consult our local agents.				
Maximum travel (m)	250 *4							Please consult our local agents.				
Minimum floor height (mm)	2500 *5											

Notes:  
 \*3: Please consult our local agents if the maximum travel exceeds the values specified in the above table.  
 \*4: Excluding the rated capacity 2250kg to 3000kg. Please consult our local agents for maximum travel.  
 \*5: For some elevator specifications, the floor height (distance between floors) must be a minimum of 2500mm.  
 Please consult our local agents if the floor height is less than "Entrance height HH + 700mm".

## Door System

Standard	2-panel center opening (CO)
Optional	2-panel side sliding opening (2S) or 4-panel center opening (2CO)

## Operation System

Standard	1-car selective collective (1C-2BC)
Optional	2-car group control system (2C-2BC), 3 or 4-car group control ΣAI-22 system, or 3 to 8-car group control ΣAI-2200C system

# Important Information on Elevator Planning

## Work Not Included in Elevator Contract

- The following items are excluded from Mitsubishi Electric's elevator installation work, and are therefore the responsibility of the building owner or general contractor:
- Construction of the elevator machine room with proper beams and slabs, equipped with a lock, complete with illumination, ventilation and waterproofing.
  - Access to the elevator machine room sufficient to allow passage of the control panel and traction machine.
  - Architectural finishing of the machine room floor, and the walls and floors in the vicinity of the entrance hall after installation has been completed.
  - Construction of an illuminated, ventilated and waterproofed elevator hoistway.
  - A ladder to the elevator pit.
  - The provision of cutting the necessary openings and joists.
  - Separate beams, when the hoistway dimensions markedly exceed the specifications, and intermediate beams when two or more elevators are installed.
  - All other work related to building construction.
  - The machine room power-receiving panel and the electrical wiring for illumination, plus the electrical wiring from the electrical room to the power-receiving panel.
  - The laying of conduits and wiring between the elevator pit and the terminating point for the devices installed outside the hoistway, such as the emergency bell, intercom, monitoring and security devices, etc.
  - The power consumed in installation work and test operations.
  - All the necessary building materials for grouting in of brackets, bolts, etc.
  - The test provision and subsequent alteration as required, and eventual removal of the scaffolding as required by the elevator contractor, and any other protection of the work as may be required during the process.
  - The provision of a suitable, locked space for the storage of elevator equipment and tools during elevator installation.
  - The security system, such as a card reader, connected to Mitsubishi Electric's elevator controller, when supplied by the building owner or general contractor.

\* Work responsibilities in installation and construction shall be determined according to local laws. Please consult our local agents for details.

## Elevator Site Requirements

- The temperature of the machine room and elevator hoistway shall be below 40°C.
- The following conditions are required for maintaining elevator performance.
  - a. The relative humidity shall be below 90% on a monthly average and below 95% on a daily average.
  - b. Prevention shall be provided against icing and condensation occurring due to a rapid drop in the temperature in the machine room and elevator hoistway.
  - c. The machine room and the elevator hoistway shall be finished with mortar or other materials so as to prevent concrete dust.
- Voltage fluctuation shall be within a range of +5% to -10%.

## Ordering Information

Please include the following information when ordering or requesting estimates:

- The desired number of units, speed and loading capacity.
- The number of stops or number of floors to be served.
- The total elevator travel and each floor-to-floor height.
- Operation system.
- Selected design and size of car.
- Entrance design.
- Signal equipment.
- A sketch of the part of the building where the elevators are to be installed.
- The voltage, number of phases, and frequency of the power source for the motor and lighting.



Mitsubishi Elevator Inazawa Works has acquired ISO 9001 certification from the International Organization for Standardization based on a review of quality management. The company has also acquired environmental management system standard ISO 14001 certification.





for a greener tomorrow

Eco Changes is the Mitsubishi Electric Group's environmental statement, and expresses the Group's stance on environmental management. Through a wide range of businesses, we are helping contribute to the realization of a sustainable society.

**mitsubishi electric corporation**  
HEAD OFFICE : TOKYO BLDG., 2-7-3, MARUNOUCHI, CHIYODA-KU, TOKYO 100-8310, JAPAN

Visit our website at:  
<http://www.mitsubishielectric.com/elevator/>

 **Safety Tips:** Be sure to read the instruction manual fully before using this product.

Revised publication effective Apr. 2014  
Superseding publication of C-CL1-4-C9315-A Feb. 2014  
Specifications are subject to change without notice.

©2014 Mitsubishi Electric Corporation